

PISTON PRESSURE SWITCH

DS-507 / DS-502



INTRODUCTION

We are known throughout Europe as a leading specialist for piston pressure switches and provide our customers with a broad range of pressure switch designs.

Many years of experience with material combinations, processing techniques and production tolerances enable us to meet the most varied requirements in a targeted and flexible manner.

Our pressure switches are distinguished by their durable precision, a broad spectrum of applications and uncompromising reliability.

The DS 507/502 is the “standard” pressure switch. It is, in common with the DS 307/302, precise and durable, but less variable. The broad range of applications for which it is employed includes cycle (clock) functions in industrial applications, activation functions in mobile applications and monitoring functions in wind power plants.

FUNCTION

The pressure switch functions on the basis of the piston-spring principle. The microswitch (2) is actuated if the pressure lies below the configured value. The piston (6) acts against the spring plate (5) when pressure builds up. This braces itself against the continuously-adjustable compression spring (4). The piston (6) transfers the force of onto the spring plate (5) when the configured pressure is reached on the nozzle (7), enabling the microswitch (2) and triggering an electrical signal. The pressure to be monitored is determined by the preload tension of the spring (4). Adjustment is achieved by turning the adjusting element (3). Anticlockwise rotation reduces the switching pressure, while turning in a clockwise direction increases the switching pressure. The adjusting element (3) is fixed with the securing screw. A mechanical stop prevents the compression spring (4) from seizing due to excessive turning.

CONTENTS

	Page
Introduction	1
Function	1
Technical Data	2
Ordering information	3
Terminal assignment	3
Reset differential pressure	4
Dimensions	5-6

ADDITIONAL INFORMATION

Further information on the correct handling of our pressure switch range is available under “Operating manual for piston pressure switches” BA-KDS/GB/2010-REV1 on our website www.hydropa.de.

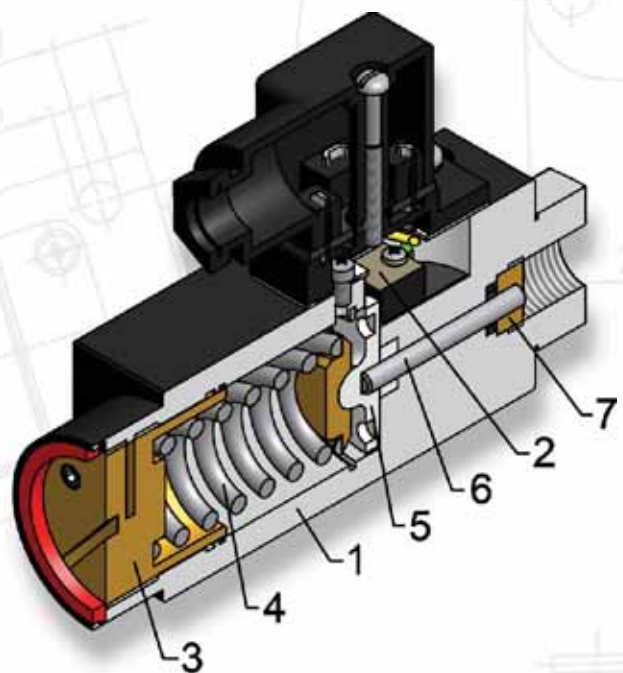

TECHNICAL DATA

General information	
design	piston spring-loaded, mechanical stop prevents compression spring seizing due to excessive turning
connection	internal G 3/8 thread or flange surface
adjusting	adjusting screw cover or adjusting knurl
setting protection	fixing cover or lockable adjusting knurl (E10 H2 closure)
installation	arbitrary
weight	basic type 0,5 kg

Hydraulic					
piston diameter	ø 4 mm		ø 5 mm	ø 6 mm	
switching pressure ranges	20-350 bar	40-240 bar	20-150 bar	10-100 bar	5-55 bar
P max. (standard seal)	500 bar	500 bar	500 bar	400 bar	300 bar
P max. (SS-seal ¹⁾)	400 bar	400 bar	-	200 bar	200 bar
repetitive accuracy	deviation less than 1% (depending on operating range)				
ambient temperature	- 40 °C to + 90 °C				
pressure fluid	oil, oil-water-emulsion				
viscosity range	10 bis 800 mm ² /s				
load change	≥5×10 ⁶				

Electrical	
switch element	electromechanical changeover switch CEE 24; VDE 0630, T85 UL 1054/CSA C22.2 No. 55 6 TSD, T90 pure silver profile contact, gold on silver palladium coated profile contact on request
voltage type	alternating voltage / direct voltage
protection class DIN 60529	IP 65, IP 68 on request
electrical connection	cable socket conforming to EN 175301-803, model type A, Pg9 (Pg11 on request)
cable cross-section	0,5 mm ² to 1,5 mm ²
cable diameter	6 mm to 8 mm for Pg9 / 8 mm to 10 mm for Pg11
seal	outer jacket seal

Switching power		
voltage	250 V/AC	24 V/DC
max. ohmic load	5 A	5 A
max. inductive load	1 A	4 A

Other details	
housing	black painted aluminium
pressure connection	aluminium
switch movement	approx. 0.5 mm consequently very little wear on seal and tappet guide
connection plates	for NG 6 and NG 10 valve linking (only for pressure switches suitable for flange connection)

¹⁾ special low-friction seal

SERVICE LIFE

The service life of a piston pressure switch depends on numerous factors. Minimum and maximum pressures, cycle rate, load change, hydraulic vibration, the load (amp.) on the electrical switch, etc. Where a pressure switch needs to meet special requirements, we are in a position to address the most varied requirements in a flexible and targeted manner, thanks to our years of experience with material pairings, machining processes and production tolerances.

ORDERING INFORMATION

DS-5** / / - / / /

basic type DS-507 or DS-502

undesign. = pipe installation
F = flange connection
SCH = panel installation
V2 = adjusting knurl with scale
AS-H2 = lockable adjusting knurl with scale (E10 H2 closure)
SS¹⁾ = special low-friction seal, only for following pressure ranges:
 5- 55 bar 10-100 bar
 40-240 bar 20-350 bar

(several additional details separated by slash)

Fixed switching points preset by manufacturer:
 - standard pressure rising
 - falling if desired

Switching pressure ranges	p _{max.} standard	p _{max.} special SS seal
055 = 5- 55 bar	300 bar	200 bar
100 = 10-100 bar	400 bar	200 bar
150 = 20-150 bar	500 bar	-
240 = 40-240 bar	500 bar	400 bar
350 = 20-350 bar	500 bar	400 bar

(several additional details separated by slash)

P90 = with 90° elbow connection plate
 (p_{max.} = 350 bar)
PO = sealable
 (not for versions with scales)
undesign. = cable socket conforming to EN 175301-803 model type A, Pg9 (Pg11 on request)
L-MP 24 = 4-pole 24 V lamp socket
L-MP 220 = 4-pole 220 V lamp socket
LED-34 = 4-pole socket with LED function display
AUX¹⁾ = gold on silver palladium
S¹⁾ = Viton®fluoroelastomers

¹⁾Special versions not in stock!

Viton® is a registered trademark of DuPont Performance Elastomers.

TERMINAL ASSIGNMENT

1. Terminal assignment DS-507 (standard)

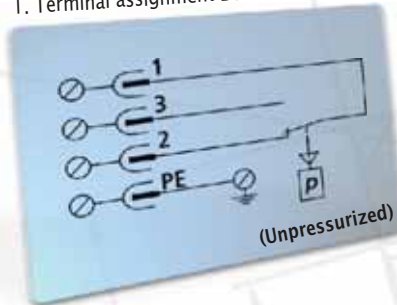

2. Terminal assignment DS-502

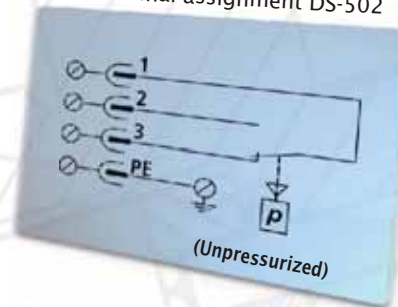

Terminals 1-2: contact breaks if pressure rises
 Terminals 1-3: contact makes if pressure rises

Terminals 1-3: contact breaks if pressure rises
 Terminals 1-2: contact makes if pressure rises

! The protective earth (PE) should be connected in compliance with regulations for the electrical connection. !



(see ordering information for cable sockets)
 Special solutions possible on request



Connector conforming to EN 175301-803



M12x1 connector, 4-pole available on request (only 24 V DC)



(M12x1 cable socket available on request)

RESET DIFFERENTIAL PRESSURE

1. Standard seal (normal version):

The hysteresis achieved during continuous operation is approx. 7-12 % of the final value at a set pressure of approx. 60-70 % of the max. adjustable switching pressure.

Example:

In the case of a DS-507-100 pressure switch with a pressure range of 10-100 bar, a hysteresis of approx. 7-12 bar is achieved at a set pressure of 70 bar.

2. Special low-friction seal (SS design)

The hysteresis achieved during continuous operation is approx. 3-6 % of the final value at a set pressure of approx. 60-70 % of the max. adjustable switching pressure.

Example:

DS-507/SS-100 set pressure: 70 bar --> hysteresis: approx. 3 bar

DS-507/SS-240 set pressure: 200 bar --> hysteresis: approx. 12 bar

These values depend of course on the temperature and viscosity or the operating medium. The pressure ranges with different piston diameters also influence these values.

FUNCTION DIAGRAM

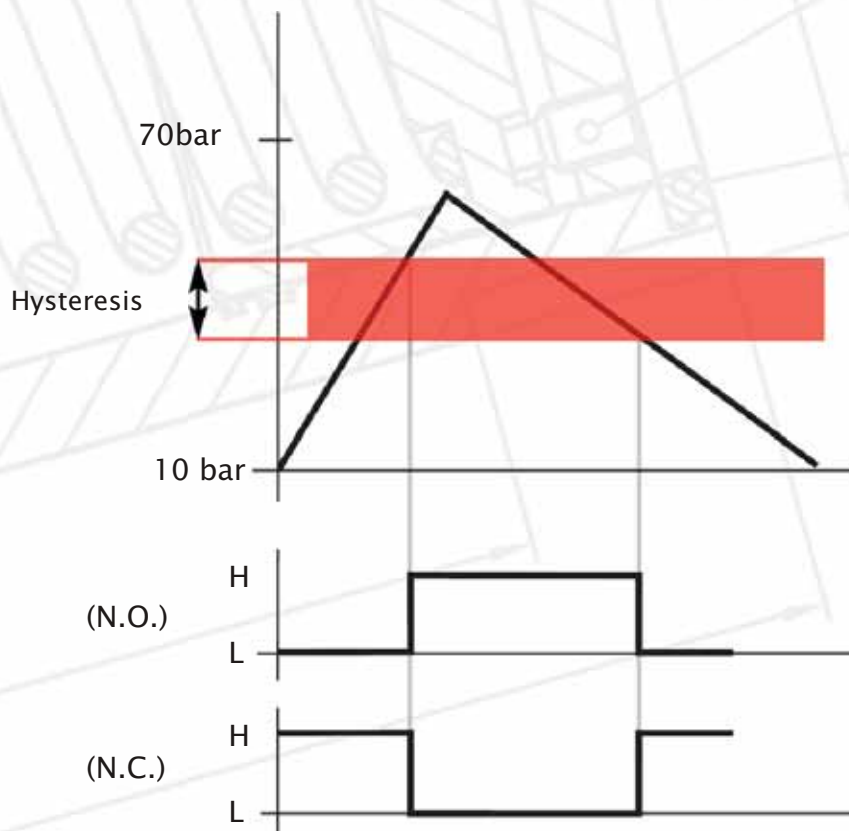

DIMENSIONS

Type DS-507/***/ or DS-502/**/

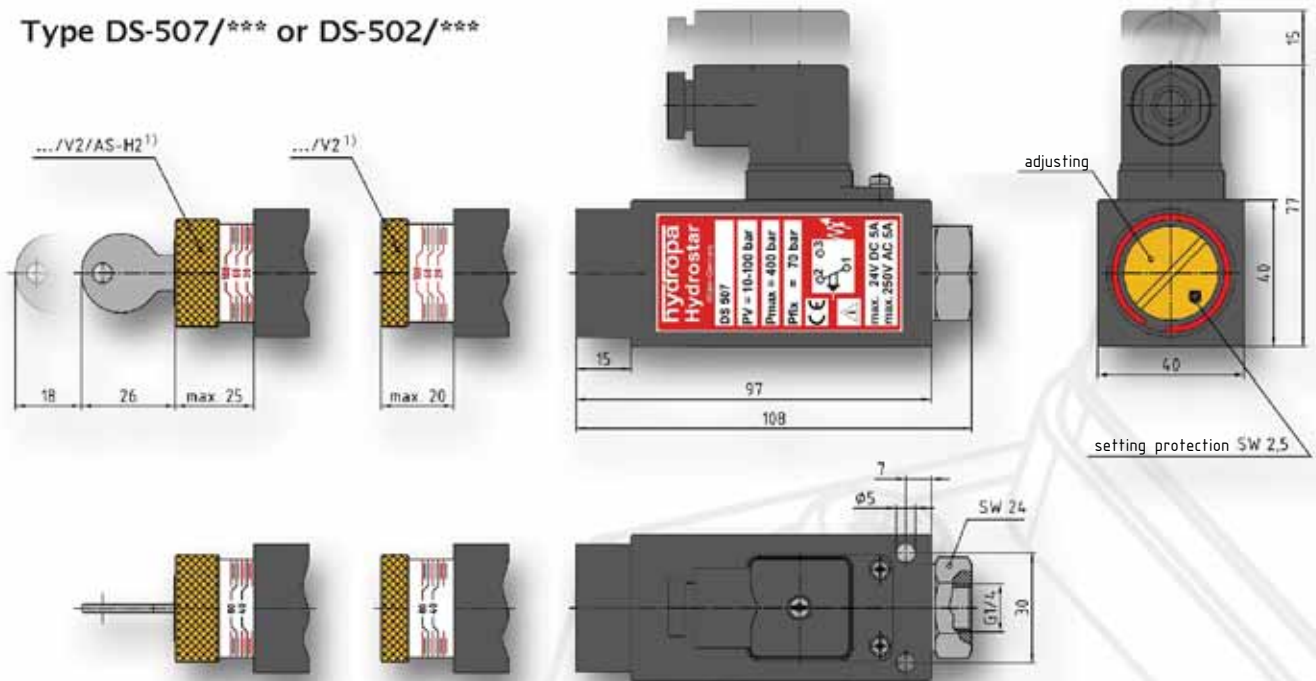

¹⁾The scale is only provided for orientation. The exact configuration of the switching pressure should be realised with a pressure gauge.

Type DS-507/F/**/ or DS-502/F/**/

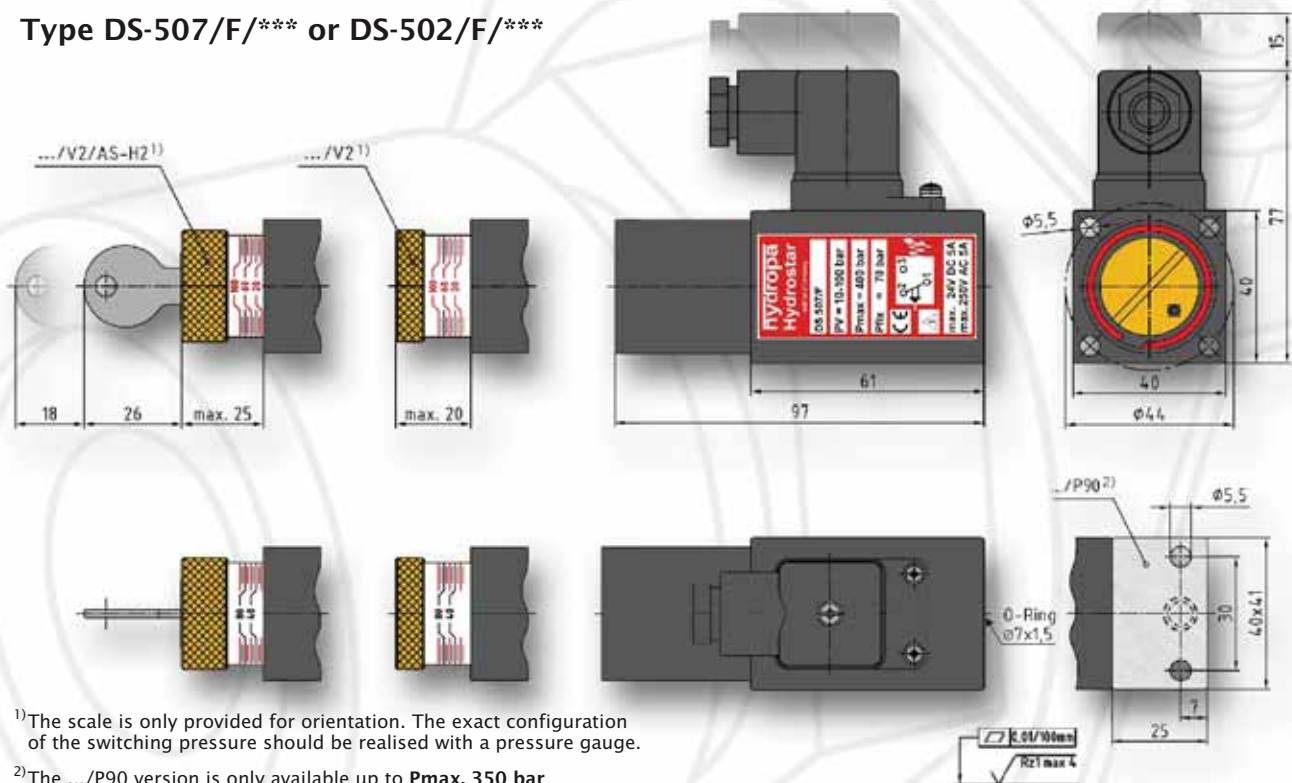

¹⁾The scale is only provided for orientation. The exact configuration of the switching pressure should be realised with a pressure gauge.

²⁾The .../P90 version is only available up to P_{max}. 350 bar (flange version only).

DIMENSIONS

Type DS-507/SCH*** or DS-502/SCH***

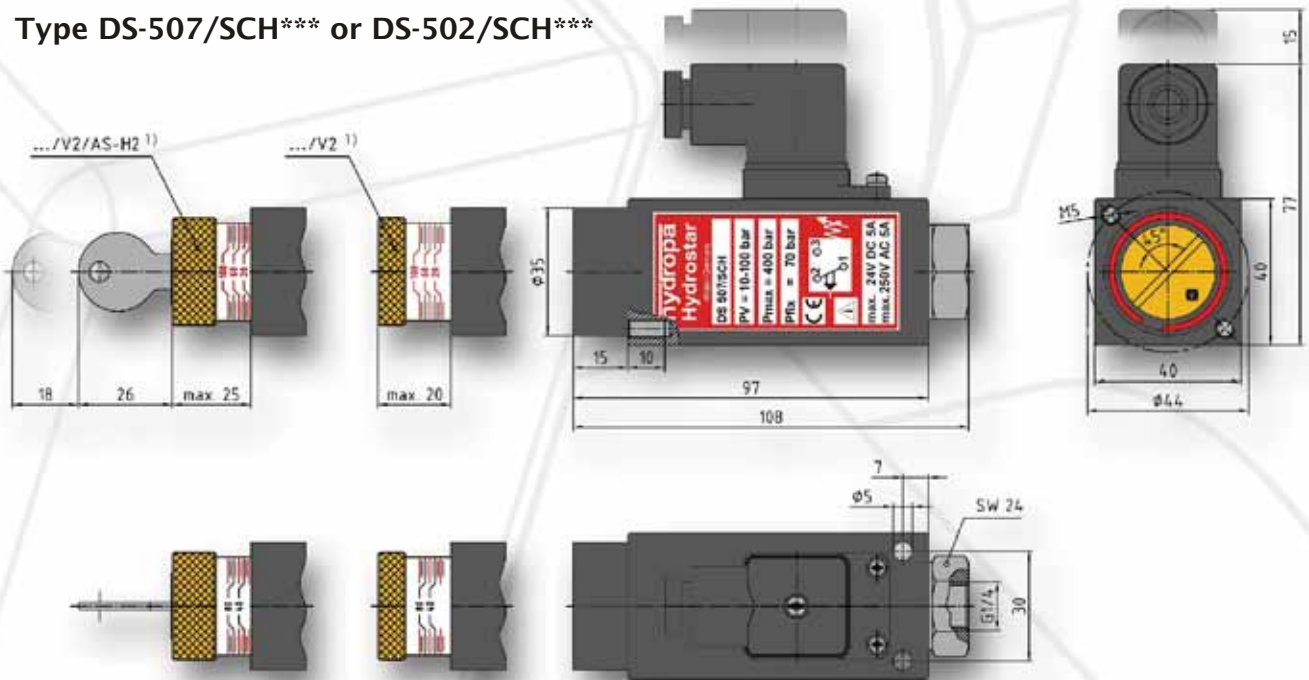

¹⁾The scale is only provided for orientation. The exact configuration of the switching pressure should be realised with a pressure gauge.

Cable sockets

